

**System 706679900****Advantage over original system:**

- all parts are new
- more light output
- very stable ignition with solid spark
- better starting, better fuel burning
- no wear anymore on points

**Generator/electronic ignition for Maico Taifun**

- Magnet based generator with integrated fully electrical ignition. Output at 12V/100W DC. Solid state ignition with own power supply from within the system. Replaces old dynamo, points and ignition coils. No changes on engine casing needed.

- The system is technically capable of running without battery.

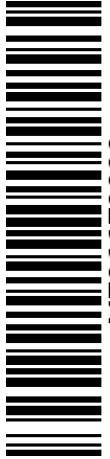

M706679900

<b>Assembly instructions for system 706679900</b>	<b>10.02.2021</b>
<p><b>- If you can install and time a stock ignition and possess basic mechanical skills, you can install a VAPE! If you never have worked on your ignition, better have it done by someone who knows.</b></p>	
<p>- VAPE can not monitor the compliance to those instructions, nor the conditions and methods of installation, operation, usage and maintenance of the system. Improper installation may result in damage to property and possibly even bodily injury. Therefore we assume no responsibility for loss, damage or cost which result from, or are in any way related to, incorrect installation, improper operation, or incorrect use and maintenance. We reserve the right to make changes to the product, technical data or assembly and operating instructions without prior notice</p>	
<p><b><u>IMPORTANT</u></b></p>	
<p><b>- Please read these instructions fully and carefully before starting work on your motorcycle</b> Please bear in mind that any modification of the material as well as own repair attempts which have not been agreed with VAPE may result in a loss of warranty. Do not cut off wires. This leads to a loss of reverse polarity protection and often results in damage to electronics. Also, please take note of the information provided on the information page for this system. Check that what you have bought really corresponds to the motorcycle you have. Wrong ignition settings may damage your engine and even hurt you during kickstart (violent kickbacks). Be careful during the first test runs. If needed change settings to safer values (less advance). During assembly check carefully that the rotor (flywheel) does not touch the stator coils or anything else, which may happen due to various circumstances and lead to severe damage.</p>	
<p><b>Designated use</b> - This system is designated to replace stock dynamo/alternator &amp; ignition systems in vintage and classic motorcycles <b>whose engine characteristics have not been modified aftermarket</b>. This system is not a tuning system and it will not bring significant increases in engine output. It does however significantly enhance roadworthiness and comfort by offering better lighting, better function of side indicators and horn and, compared with the aging stock systems, increased reliability. As our system does not tamper with engine characteristics it does not increase emission of gaseous pollutants and noise. In most cases emission of pollutants should even be reduced due to better combustion. If used as designated the system therefore will not normally infringe the existing legal status of the motorcycle. (Please check your local legal regulations!) This system is not suitable for use in competition events. If used other than the designated way, your warranty will be voided and it might well be that you do not obtain the desired results or, worst you loose legal roadworthiness.</p>	
<p> <b>- VAPE guarantees homologated products marked with the “E” mark in the ring (E8 specifically for the Czech Republic), thereby ensuring a consistent conformity of the product properties with the relevant ECE homologation regulations (especially ECE R10.05). Inspection is regularly carried out by the competent authority.</b></p>	
<p><b>- The charging system is only suitable for use with rechargeable 12V (6V systems 6V) lead-acid batteries</b> with liquide electrolyte or sealed lead-acid batteries, AGM, Gel. It is not suitable for use with nickel-cadmium, nickel-metal-hydride, lithium-ion or any other types of rechargeable or non rechargeable batteries.</p>	
<p>- This is a <b>replacement system and not a copy of the stock material</b>. The parts in this system therefore look different and might fit differently (notably ignition coil and regulator) requiring some adaptation by you.</p>	
<p><b>- During assembly imperatively start with assy of engine based parts</b> to see that those really fit before you start fitting the external parts. In many cases customers assemble those first and thereby often modify them in breach of warranty which renders them unfit for renewed sale. Replacing old ignition systems is not a matter of taking something from a supermarket shelf as there have been very many types, versions and possibly unknown aftermarket modifications which harbour plenty of room for error.</p>	
<p>- Our systems are <b>NOT tested for use with third party electronic devices (such as GPS, mobile phones, LED lighting etc) and may cause damage to such parts</b>. Possibly existing electronic tachometers will not work with the new system. Possibly existing safety switches and electronic valve controls are not supported. It might be that your motorcycle was originally equipped with an ignition that did limit top speed for legal reasons. The new system does not have such a facility, so check your legal situation beforehand.</p>	

- If you have no expertise for the installation have it done by an expert or at a specialist's workshop. Improper installation may damage the new system and your motorcycle, possibly even lead to bodily harm.

- Before you order a system, please check whether a puller tool for the new rotor is included in the kit. If not, better order it at the same time. Never use anything other than the recommended puller tool to pull the new rotor again. Damage to the rotor as a result of use of other tools or methods is not covered by your warranty.

- The rotor is sensible to blows (including during transport). Before assembly, please always check for damage (on rotor without magnet plastification try to push the magnets aside with your fingers). After impact the glued in magnets might have broken loose, sticking to the rotor solely by magnetic force, so that one does not notice right away. During engine run the damage would be considerable. Before placing the rotor onto the engine, please make sure that its magnets have not collected any metal objects such as small screws, nuts and washers. That equally would lead to severe damage.

- **If you have access to the Internet, best view those instructions online.** You get larger and better pictures by clicking onto them and possibly updated information. System list at <http://www.powerdynamo.biz>



**You should have received those parts:**

- rotor
- pre-assembled stator unit
- regulator/rectifier
- electronic twin ignition coil
- ht-cable
- relay with cables
- bits & pieces

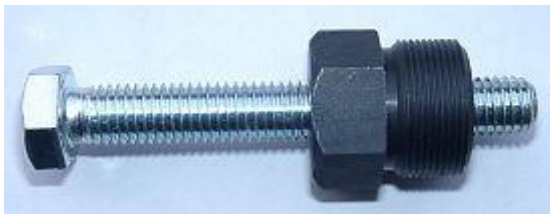

- To disengage your new rotor again, you will need a puller M27x1.25 (part-no.: 99 99 799 00 - **Not provided!**).

**Note:** Never use a claw puller, a hammer or any other device, that will shake the magnets off.

- **Notes on stock wiring:** Experience shows that have been made over time at almost any motorcycle modifications to the electrics. As a result, the wire colors, and even electrical connections or parts as such are often not identical to the original and might differ from what we describe here. If in doubt, please refer to an original wiring diagram.

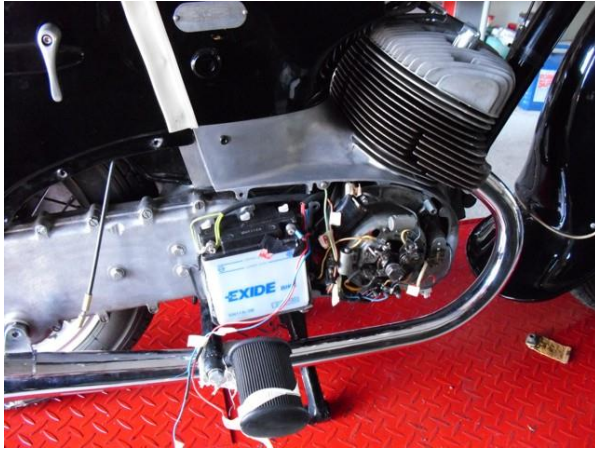

- Make sure your Maico rests securely, preferably on an elevated work bench and that you have good access to the dynamo side of the engine.
- Disconnect your battery and take it out of the motorcycle. Note, that you will be installing a 12 volt system, so you will either need a 12 volt battery or you use the option of driving without. You will still have to replace all lightbulbs to 12 volt ones. The horn may stay at 6 volts. For driving without battery, please note our information on driving without battery. Are flashers mounted you have to install instead of the battery a smoothing capacitor with at least 20.000mF/16V.



- Remove the stock generator, points and ignition coil.

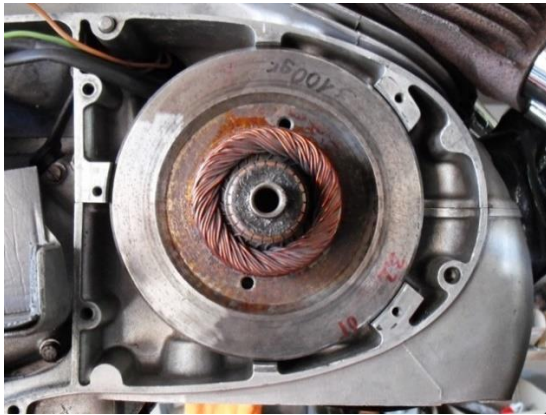

- Remove the original rotor.
- Take the woodruff key from the crank pin. It will not be needed any more and prevent assembly. If you forget this right at start, you will have to take the whole new unit off again to get access to the key.



- Put the preassembled stator unit onto the motor case. The black coils facing downwards. Positioning the elongated holes in the middle of the screw holes of the motor housing, so you have better opportunities later for the adjustment of the ignition.
- Make sure that the generator cable runs clean through the cable opening without pinching.

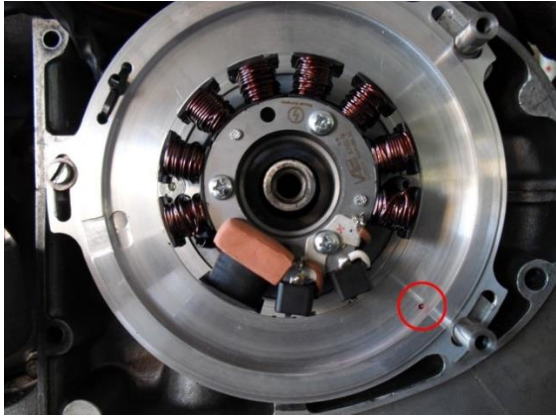

- Screw down the unit to the engine case with the stock screw and the two distance pieces (for the cover mounting). Don't forget to use the washers.

- Take a look at the stator's base plate. You will find near to the lower right fastening hole a red ignition marking (red encircled in the photo).

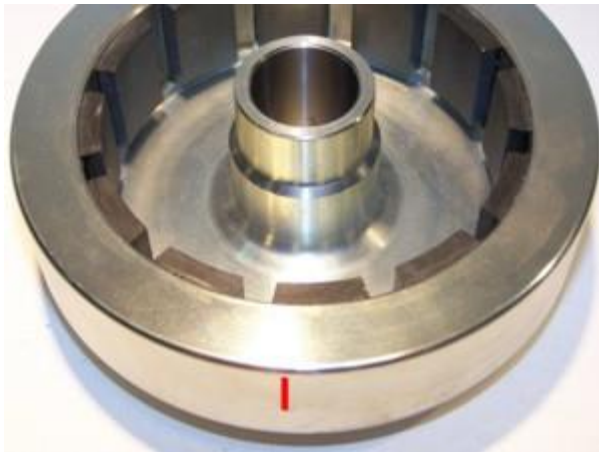

- Now take a look at the new rotor. You will find on the circumference also an ignition marking.

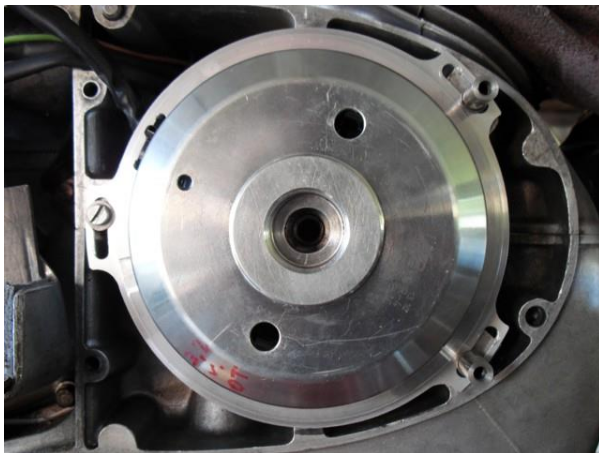

- Take the spark plug out. Put the rotor loosely onto the crank shaft for using it as a turning knob. Check that the rotor moves freely over the base plate and the stator's coils.

- Bring the piston into ignition position, the factory specification for the Maico is 3.2 mm before TDC.



- Then remove the rotor from the shaft and put the rotor carefully back on the crank shaft (without changing its ignition position) in such a way, that the marking on the rotor align with the marking on the base plate. It is very important during that procedure, not to alter the crank's ignition position, otherwise you have to redo all.

- If you'd like to alter the ignition, you can do that easily by loosening the three fastening screws of the stator unit and turning the unit in the required angle. Following, of course, you have to screw down again the unit.



- Fasten the rotor with the stock fastening screw (and a washer).

- To disengage your new rotor again, you will need a puller M27x1.25 (part-no.: 99 99 799 00 - **Not provided!**).

**- Note:** Never use a claw puller, a hammer or any other device, that will shake the magnets off.



- Mount the new ignition coil, regulator/rectifier and the relay in a suitable location (in the picture: under the seat by using a home-made mounting plate). Turn the ht-cable previously into the ignition coil. Leave one of the fastening screws loose, you have to connect a ground cable here.

- Lay the new generator cables along the frame (using the enclosed cable binders), in that way, that they finished close to the regulator resp. ignition coil. Take care that nothing's pinched.

**Connect the parts as shown in the respective wiring diagram!**

- For our standard DC regulator (95 22 699 06), use the wiring diagram **72ir12**.
- For our DC regulator with built in smooting condenser (73 00 799 50), use additional the wiring diagram **reg\_102**

- To facilitate wire exit through the often small openings in the engine casing, the plastic plug of the generator's wiring that leads to the ignition coil have not been put onto the wire terminal. You should place the plug there only once all has been properly installed on the engine side.

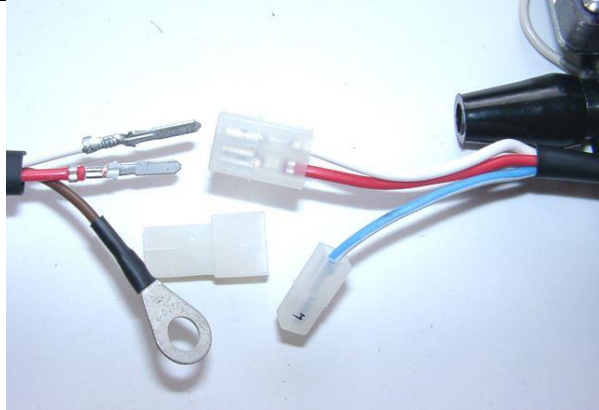

- Look for the ignition coil with its female plug and the two wires (red and white).
- Put the provided 2-position plug housing onto this plug and insert the two wires (red and white) from the generator. Make sure that the terminals engage securely in the housing and that you connect:
  - white to white
  - red to red

- Should you need (or want) to get the terminals out of the plug housing again, enter a paper clip from front next to the terminals and push the little barb aside. Than pull the wire out.

- The brown wire from the new generator with the round eye terminal have to be screwed to the holder frame of the ignition coil (ground). This connection is very important. Please don't depend on the frame as *the* earth-connection. Varnish, oil and dirt prevent often a good contact!

**Connecting Powerdynamo alternator to lighting circuit (via regulator):**



- The 2 black wires running from the stator coil carry the voltage for lights, horn, flashers etc. They have nothing to do with ignition.
- This voltage (something between 10 and 50 volts AC) has however to be stabilized (regulated) and for most uses rectified into direct current (DC) as it primarily is alternating current (AC).
- **For this we offer 2 different regulators:**

**Attention:** Any confusion between plus and minus (with the DC versions) leads to immediate destruction of the regulator. This will not constitute a warranty case as it is negligence! One can recognize a burnt regulator mostly by its sharp smell.

**Regulator type 1: with standard DC regulator (95 22 699 06), use the wiring diagram 72ir12:**

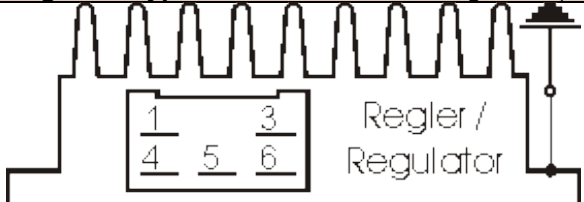

-The new regulator/rectifier has a compact plug with 6 positions, of which *one* is not used. A female plug cover fitting to this plug is delivered. Into this female plug you have to insert the following wires (which have terminals that snap into the plug):

<p>The two black cables leading from the generator ...</p>	<p>... connect to pins 1/4 of the new regulator (from there equally black wires lead inside the unit). It does not matter which wire connects to which of the both terminals (1/4) as they carry alternating current.</p>
<p>The new brown cable with the round eye terminal.</p>	<p>... connects pin 3 of the regulator unit (from there equally a brown wire goes inside the unit) with the negative pole of the battery or (in case you drive without battery) to ground (chassis).</p>
<p>The new red cable with the round eye terminal ...</p> <p style="text-align: center;"><b>Take care: Wrong polarity will damage the electronics!</b></p>	<p>... connects to pin 5 of the new regulator (from there equally a red wire goes inside the unit). This wire is a major integration point between the old and the new system. Here your regulated positive voltage comes out to connect to battery plus, or (in case you drive without battery) to the voltage input terminal of the main switch (ignition lock, German bikes: pin 51/30).</p>
<p>Make sure that you have a <b>15A-fuse</b> between battery and vehicle circuitry.</p>	
<p>The green/red wire at pin 6 of the new regulator ...</p>	<p>... is for the charge control light. You connect there the wire that formerly did run from the control light to the original regulator.</p> <p>- Sure that this control only functions with a battery present. Should you drive without battery but still connect the wire, you will see that the light glows even as the generator generates voltage. So without battery, do not connect it.</p>
<p>- The charge light control function is based on a transistor switch and is an additional function. Even if that should fail, the regulator might still be in ok working condition. Simple check: have the engine running, turn lights on, disconnect the battery. If you have bright lights the unit is ok.</p>	
<p><b>Regulator type 2:</b> with DC regulator with built in smooting condenser (73 00 799 50), use additional the wiring diagram <b>reg_102</b>:</p>	
<p>The diagram shows a regulator unit with three main wires: two black wires labeled 'SW' (AC input), a red wire labeled 'rt' (12V DC output plus), and a brown wire labeled 'br' (ground). The SW wires are connected to a switch symbol. The rt wire is connected to a battery symbol. The br wire is connected to a ground symbol. The regulator unit is represented by a vertical rectangle with internal connections.</p>	<ul style="list-style-type: none"> <li>▪ the 2 black (sw) wires are the AC input from the alternator (as it is AC it does not matter which black to which black)</li> <li>▪ the red (rt) wire is the 12V DC output plus</li> <li>▪ the brown (br) wire is ground, internally connected to housing</li> </ul>

<p>- Remains the blue (sometimes blue/white) wire at the ignition coil. This is the kill (cut-off) wire.</p> <p><b>- Connected to ground - it will stop ignition!</b></p> <p style="text-align: center;"><b><u>Note:</u></b></p> <p>- Should you experience ignition failures, disconnect as a first measure this blue wire. In many cases that will permit you to get mobile again</p>	<p><b>- <u>Switch off via separate kill switch</u> (when driving without battery):</b> The relay will not be fitted. The blue(/white) cable of the ignition coil will be connected to a kill switch, closing against ground (a button at the handlebars). Or you mount an ignition lock that has a facility to connect against ground when in OFF position.</p> <p><b>- <u>Battery method:</u></b> Connect the brown relay wire to good ground. Lead the longer black wire from the relay to the wire that did run previously to a pin carrying voltage when the switch is on (in German bikes: pin 15) and connect it there. Connect the blue wire from pin 30 of the relay to the blue(/white) wire at the new ignition coil. Should your battery fail on the road, just disconnect that blue wire and your bike will run again (it will now only not stop by switching off).</p>
---	---

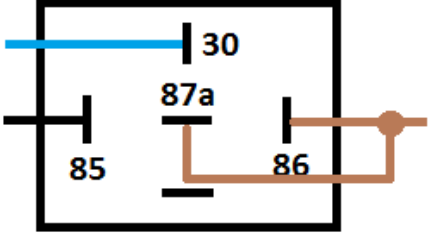
<p style="text-align: center;"><b><u>Relay wiring</u> (if used):</b></p> 	<p>- The brown wire with the ring terminal from pins 87a and 86 goes to ground.</p> <p>- The black wire from pin 85 goes to a main switch terminal carrying voltage if switched on.</p>
<p>Screw the high tension (ignition) cable ...</p> <p>- Please <b>do not use</b> any spark amplifying cables, such as "Nology supercables" or "hot wire". This will disturb the system and possibly damage it.</p>	<p>... into the ignition coil and pull over the rubber seal before mounting the coil (it will be easier).</p> <p>- Please do use the cable arriving with the pack and not any old cable.</p>

- You will do yourself a favour to treat your bike to new spark plugs and spark plug sockets (preferably some between 0-2kOhm). Plenty of problems are to be traced back to "apparently good" (even completely "brand-new") sparks plugs, terminals and cables.

**- Do not use** spark plugs with an intern suppression resistor. NGK (e.g.) offered such spark plugs coded with an "R" (for resistor).

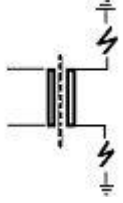
		<p>- In our twin outlet coils both ends of the secondary go to the spark plugs.</p> <p>- Typical resistance between both exits is 6.2kOhm. Both exists fire at the same time (as many twin systems do). Sparks will be polarised however at a 180 degrees difference which might manifest when you strob it.</p>
---	---	--

- Ignition will only work correctly if both plug terminals are connected. You may not test one side with the other open (not sitting on the mounted spark plug). This is because (effectively) each exit uses ground from the other. That means also that both plugs are working in serial, adding resistances, so better use low resistance spark plug (resistor) sockets and make sure they are good. If in doubt, measure resistance on a **hot** socket (warm it up before measuring).
- Is the flow from ground of one side via spark plug there, via coil, to the other spark plug and its ground interrupted you get no spark - on neither side. If you really want to test only one side, put the HT wire of the other to ground (earth it) than it will work. Sometimes a coil deprived of its ground from the other side searches for a substitute - with some solid fireworks around it to the chassis.
- Finally - **and before installing the battery and before the first kickstart** - please re-check carefully all connections and fitments against the wiring diagram. Do check battery and light bulbs for correct voltage (12V).
- Should something not work, please consult our trouble-shooting guide on our homepage. As a first step disconnect the blue wire from the coil and re-test.
- **IMPORTANT:** During **crank shaft repair** the dynamo shaft is often machined and gets shorter. The result is a rotor sitting lower, possibly touching now with its rivets the stator coil. The result is a destroyed stator and ignition failure.

### Important safety and operating information

- Safety first! Please observe the general health and safety regulations motor vehicle repair (MVR) as well as the safety information and obligations indicated by the manufacturer of your motorcycle. The timing marks on the material are for general guidance only during first installation. Please check after assembly by suitable means (stroboscope) that settings are correct to prevent damage to the engine or possibly even your health. You alone are responsible for the installation and the correctness of settings.
- Ignition systems generate high tension! With our material right up to 40,000 Volts! This may, if handled carelessly, not only be painful, but outrightly dangerous. Please do keep a safe distance to the electrode of your spark plug and open high tension cables. Should you need to test spark firing, hold the spark plug socket securely with some well insulating material and push it firmly to solid ground of the engine block.  
Never pull sparkplug caps when engine is running. Wash your vehicle only with engine at standstill and ignition off.
- You should have received the HT Cable with the fixed rubber cap (*which does not contain a resistor*) as a part of the kit, you should have to use a spark plug with an inbuilt resistor (*or replace the cap with the one containing a resistor*) to comply with your local laws (*Electromagnetic compatibility requirements*).
- Do not use a spark plug cap(s) containing a resistor **WITH** a spark plug(s) containing a resistor at the same time. It would cause problems, especially difficult engine starting. The total resistance of cap and spark plug combined should not exceed 5kOhm.
- Remember that candle plugs age, increasing resistance. If an engine only starts when it is cold, it is very likely that a defective spark plug connector or faulty spark plug is the cause. Do not use so-called ignition-reinforcing cables (e.g. Nology).
- After installation, please check tightness of all screws, even those preinstalled. If parts get loose during run, there will be inevitably damage to the material. We pre-assemble screws only loosely.
- Give the newly installed system a chance to work, before you start to check and test values, or what is worse apply changes to it.  
Our parts have been checked before delivery to you. You will not be able to check much anyway. **At any rate do refrain from measuring the electronic components (such as ignition coil, regulator and advance unit). You risk severe damage to the inner electronics there. You will not get any tangible results from the operation anyway.** Bear in mind that also your carburetor, your spark plugs and spark plug sockets (even if completely new) might be the reason for malfunction. The general experience with our systems is that the carburetor will have to be re-adjusted to lower settings. Should the system not start after assembly, first disconnect the blue (or blue/white) cut-off wire directly at the ignition coil (or in some cases advance unit) to eliminate any malfunction in the cut-off circuitry. Check ground connections carefully, make sure there is a good electrical connection between frame and engine block.

In case of troubles, please consult our Knowledge Base first before you send off the material to us for checking.

- The spark of classic, points based ignition systems has with about 10,000 Volts comparatively little energy and looks therefore yellow and fat (which however makes it highly visible). The spark from our system is a high energy spark with up to 40,000 Volts and therefore is needle thin focused in form, and blue in colour, which makes it not so visible. Furthermore you get spark only at kick-start operated speeds and not by pushing the kick-lever down slowly with your hand (as you might get with battery based ignitions).

- Systems using a twin outlet ignition coils have a few peculiarities. Please observe that during tests on one side, the other has either to be connected to an fitted spark plug or securely earthed/grounded. Otherwise there will be no spark on either side. Also with such open exits long and dangerous sparks may fly all over the coil.

- Never do electric arc welding on the bike without completely disconnecting all parts containing semiconductors (ignition coil, regulator, advance) stator and rotor need not be taken off. The same is true for soldering. Before touching electronics disconnect the soldering iron from mains! Never use copper putty on spark plugs.

- Electronics are very sensitive to wrong polarity. After work on the system, do check correct polarity of the battery and the regulator. Wrong polarity creates short circuits and will destroy the regulator, the ignition coil and the advance unit. As a rule, wiring will always be colour to colour. Instances, where colour jumps between wires are expressly mentioned in our instructions.

- When you handle the new rotor, take care not to damage its magnets. Refrain from direct blows to the circumference of the rotor. **When transporting never put the rotor over the stator.** Observe our information relative to transport of the material.

- Do not use spark plug sockets with a resistance of more than 5kOhm. Better use 1 or 2kOhm ones. Bear in mind that spark plug sockets do age and thereby increase their internal resistance. Should an engine start up only when cold, a defective spark plug socket and/or spark plug is very probably the cause. In case of problems check high tension cables too. Never use carbon fibre HT-cables, never use so called "hot wires" which promise to increase spark.

- It is a good idea to cover the rotor in a thin layer of oil to reduce the risk of corrosion.

- Never use a claw puller or a hammer to disengage the rotor. Its magnets might become loose in the event. We offer a special puller for disengaging the new rotor again (see assembly instruction)!

- Should the motorcycle not be in use for some longer period, please disconnect the battery (so existing) to prevent current bleeding through the diodes of the regulator. Though, even a disconnected battery will empty itself after a while.

- Please do observe these remarks, but at the same time, don't be afraid of the installation process. Remember, that before you, thousands of other customers have successfully installed the system.

***Enjoy driving your bike with its new electric heart!***

# VAPE Schaltplan 72ir12 (wiring diagram)

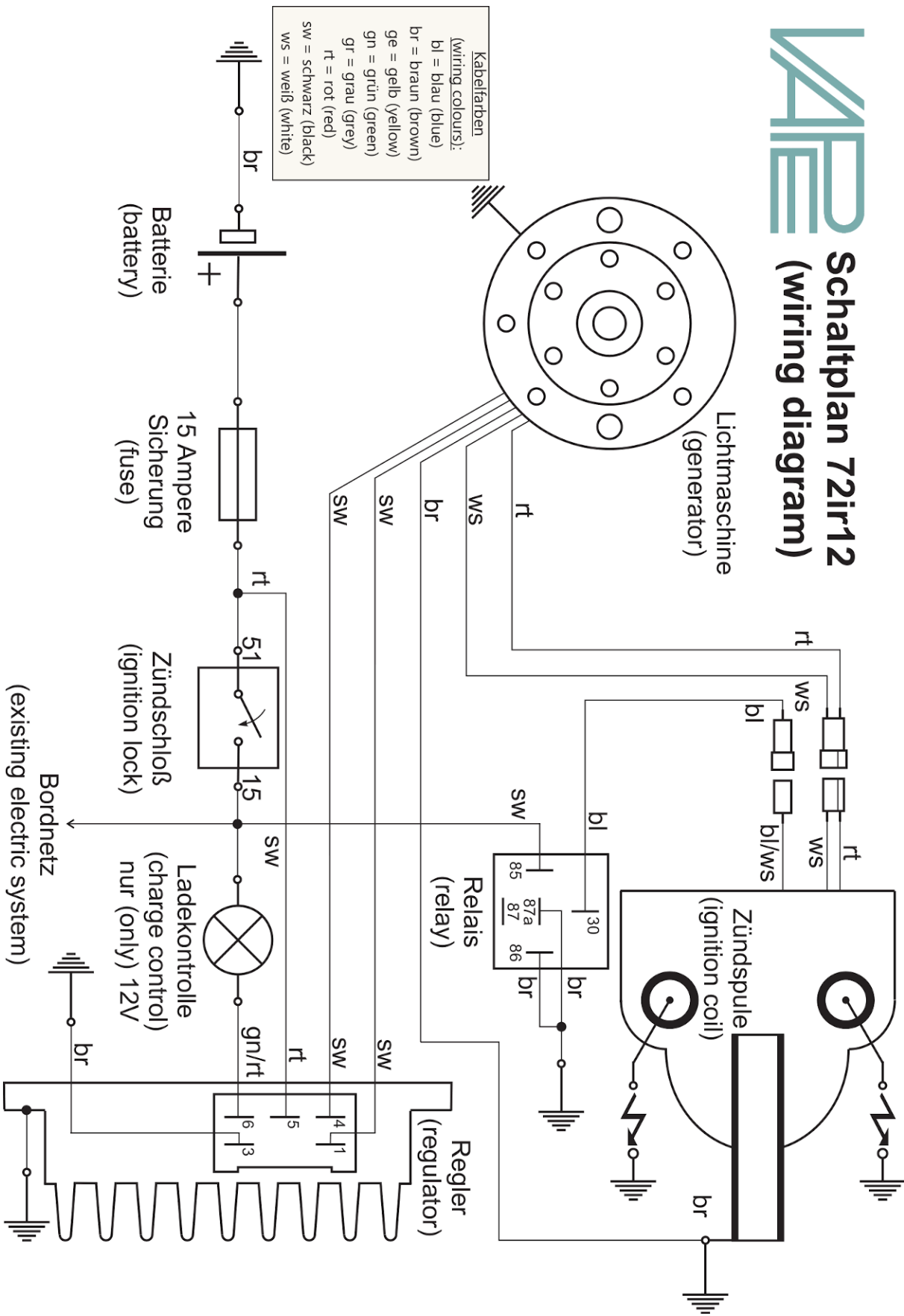

# VAPE Schaltplan Regler 102 (wiring diagram regulator)

